

# KOPFTEILE

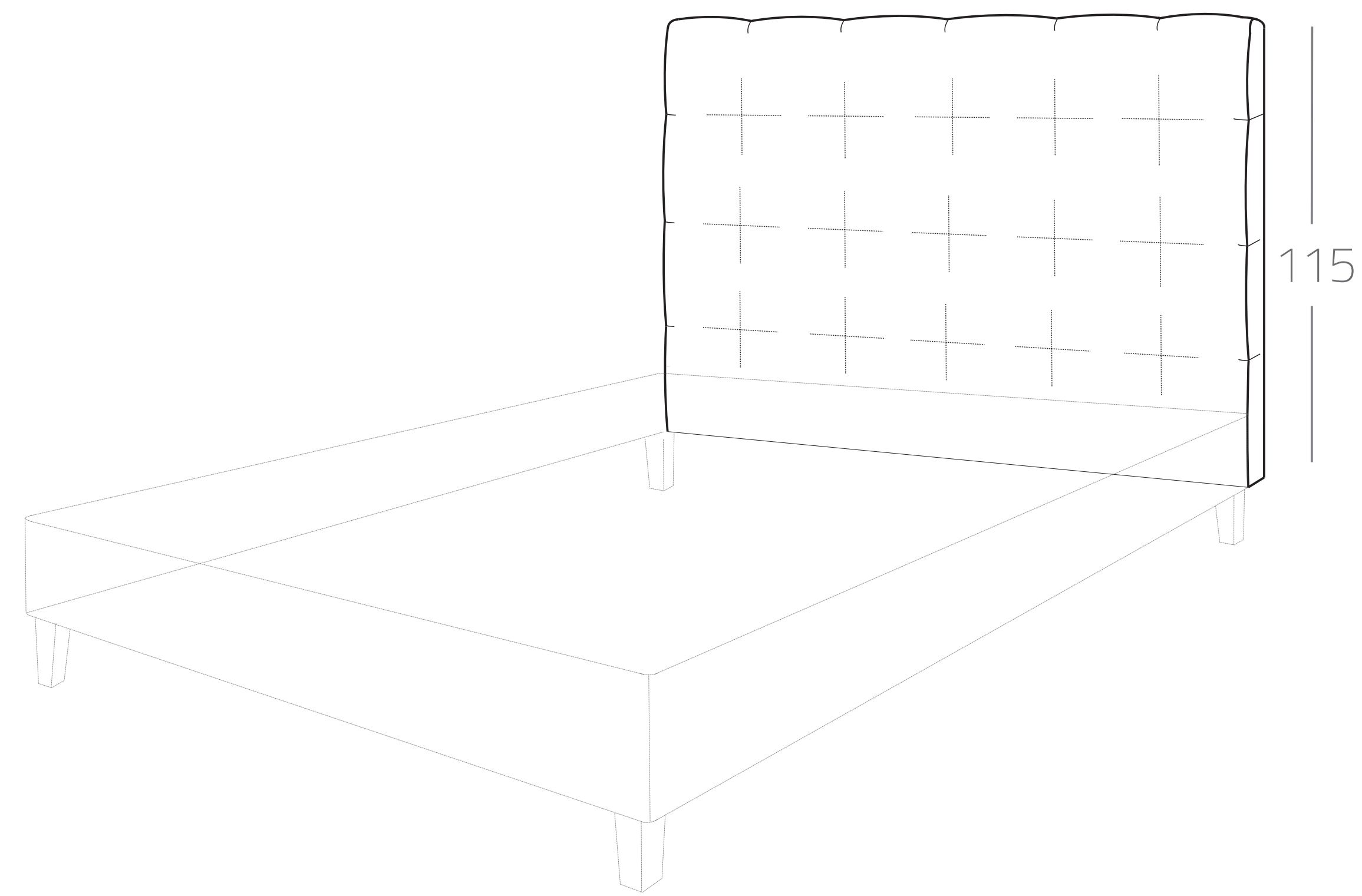

Quadratische Abnäher  
Art. Nr.: 22x.10

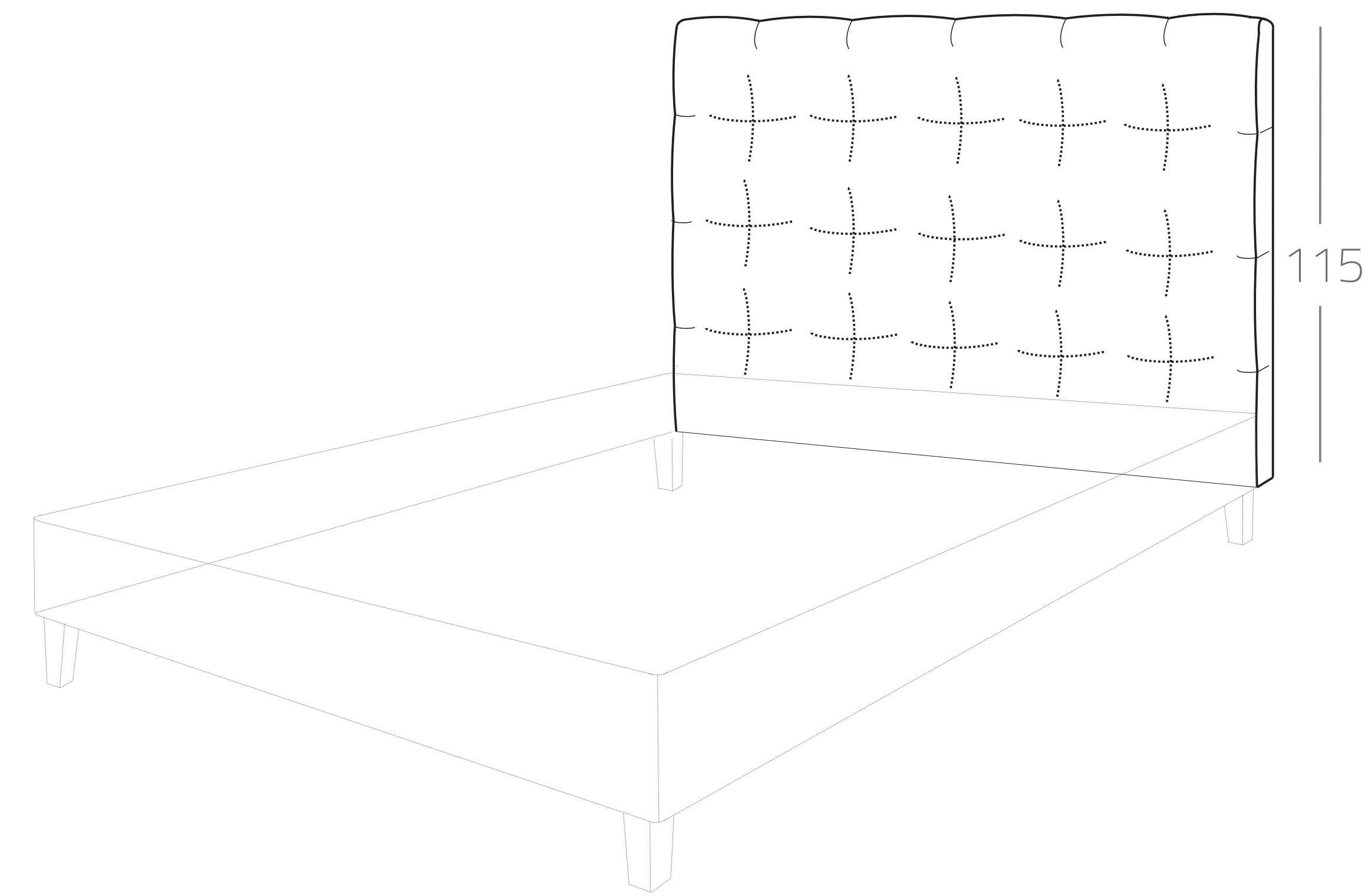

softe quadratische Abnäher  
Art. Nr.: 22x.11

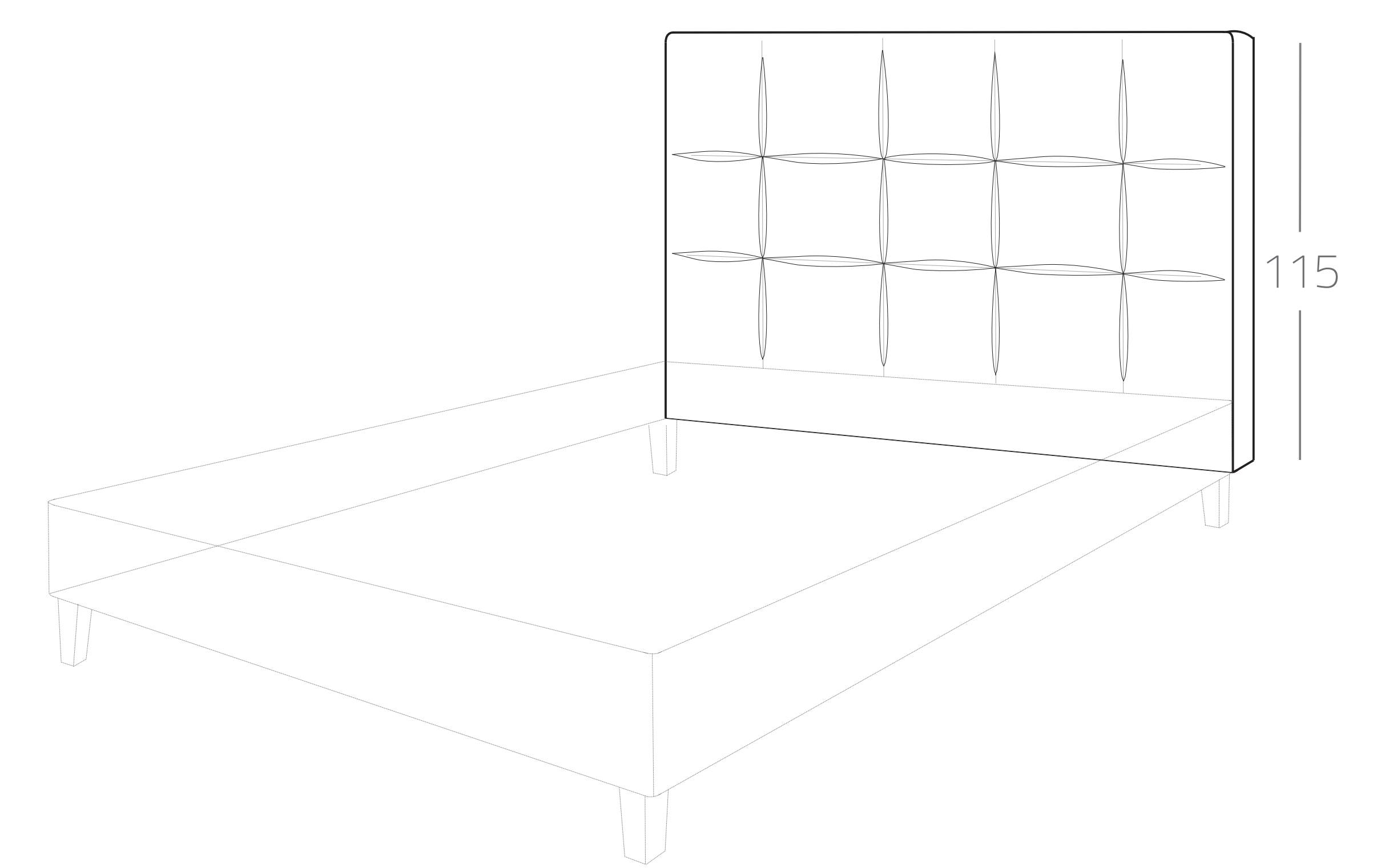

quadratische Faltung & Keder  
Art. Nr.: 22x.16

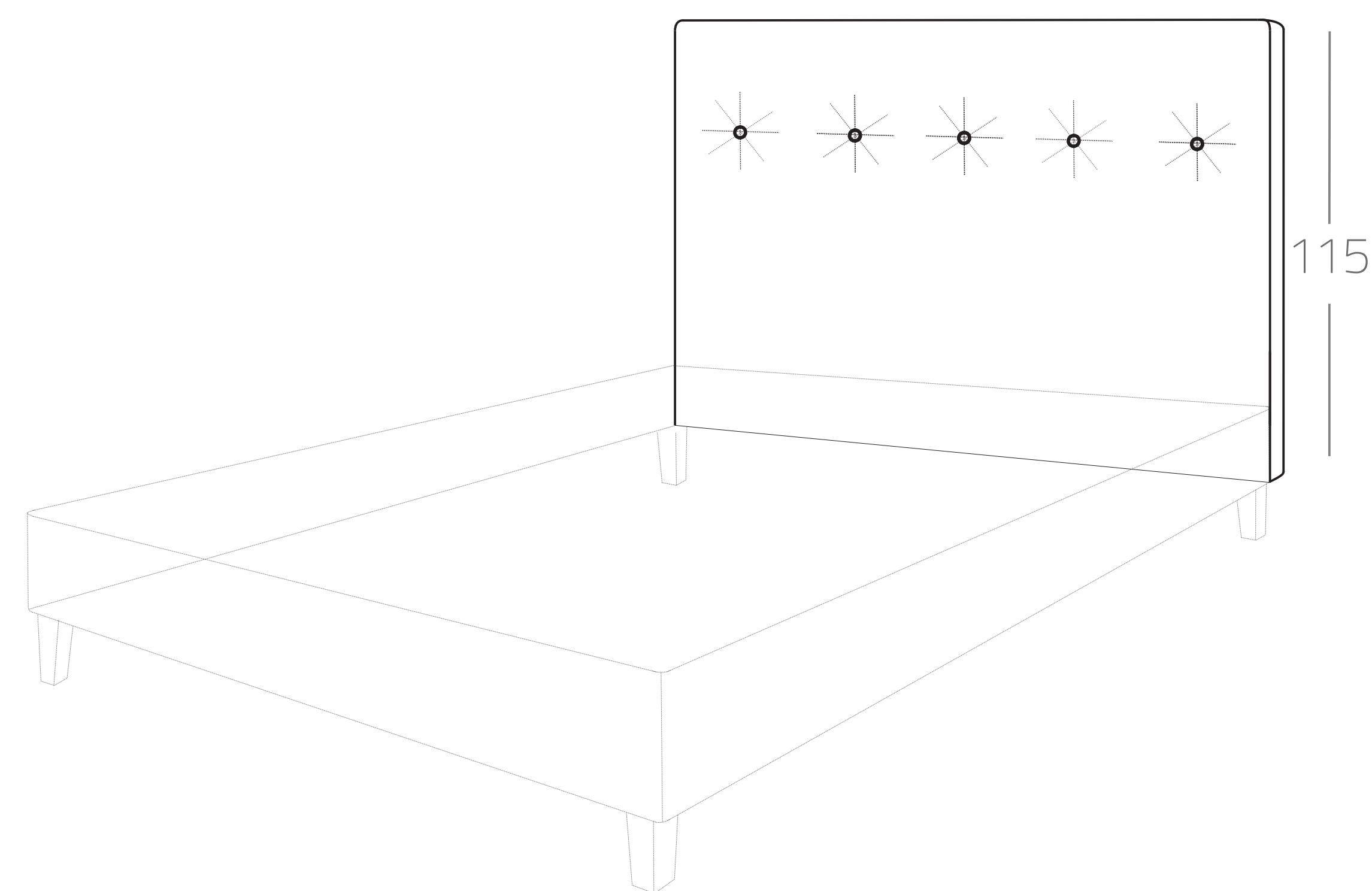

Knopfreihe  
Art. Nr.: 22x.14

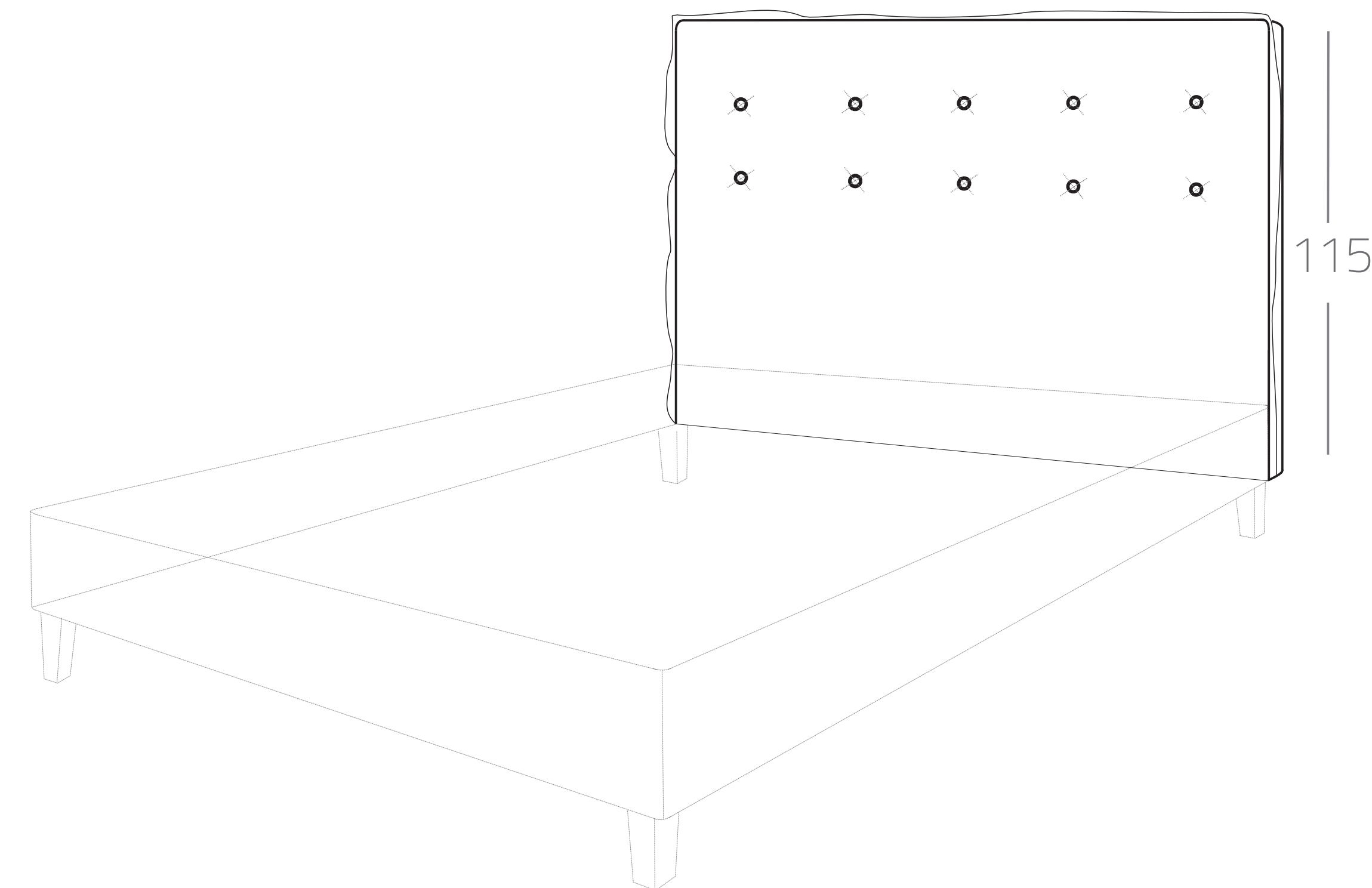

Punktabnäher mit Hohlraum  
Art. Nr.: 22x.15

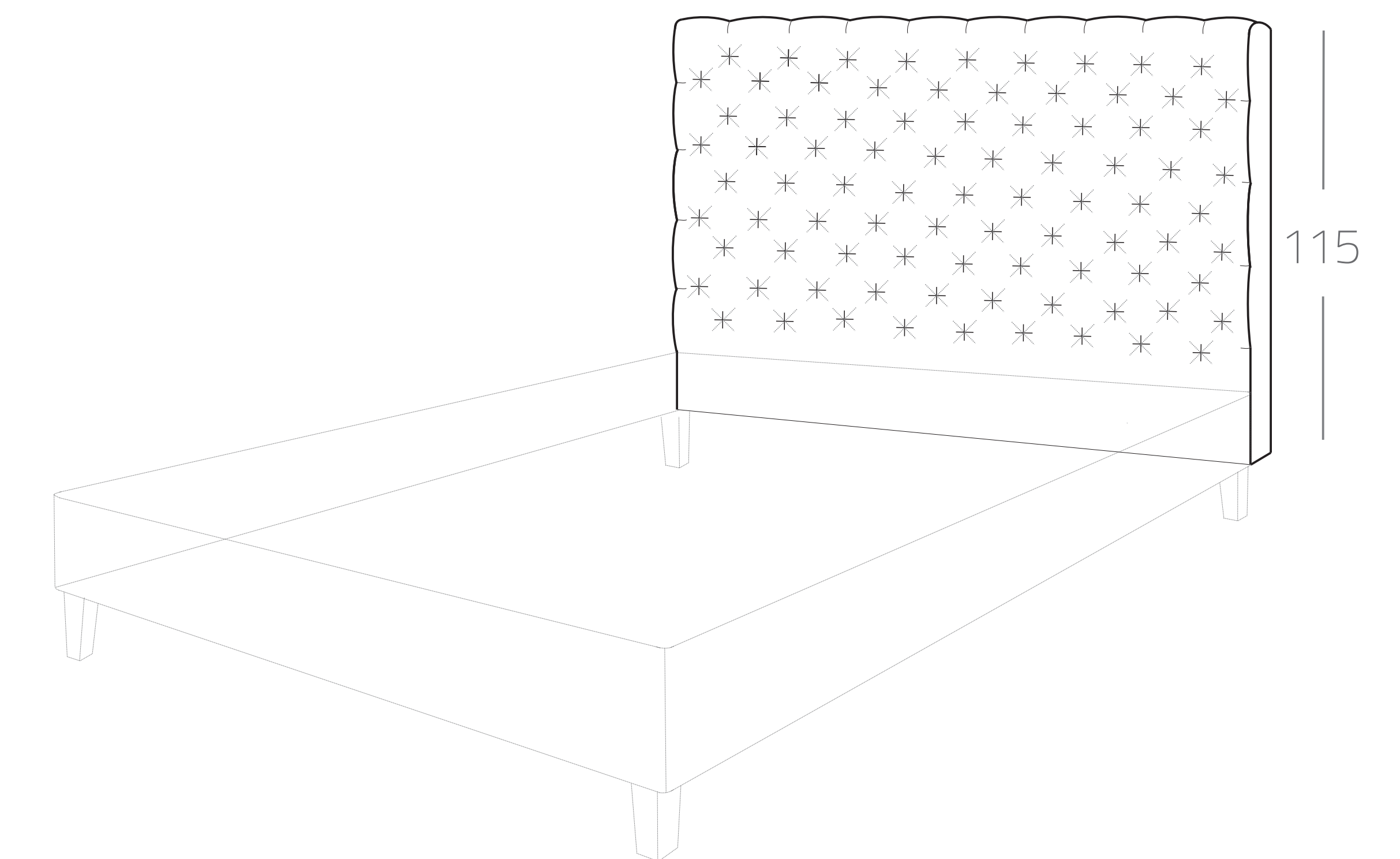

rautenförmige Abnäher  
Art. Nr.: 22x.12

# KOPFTEILE

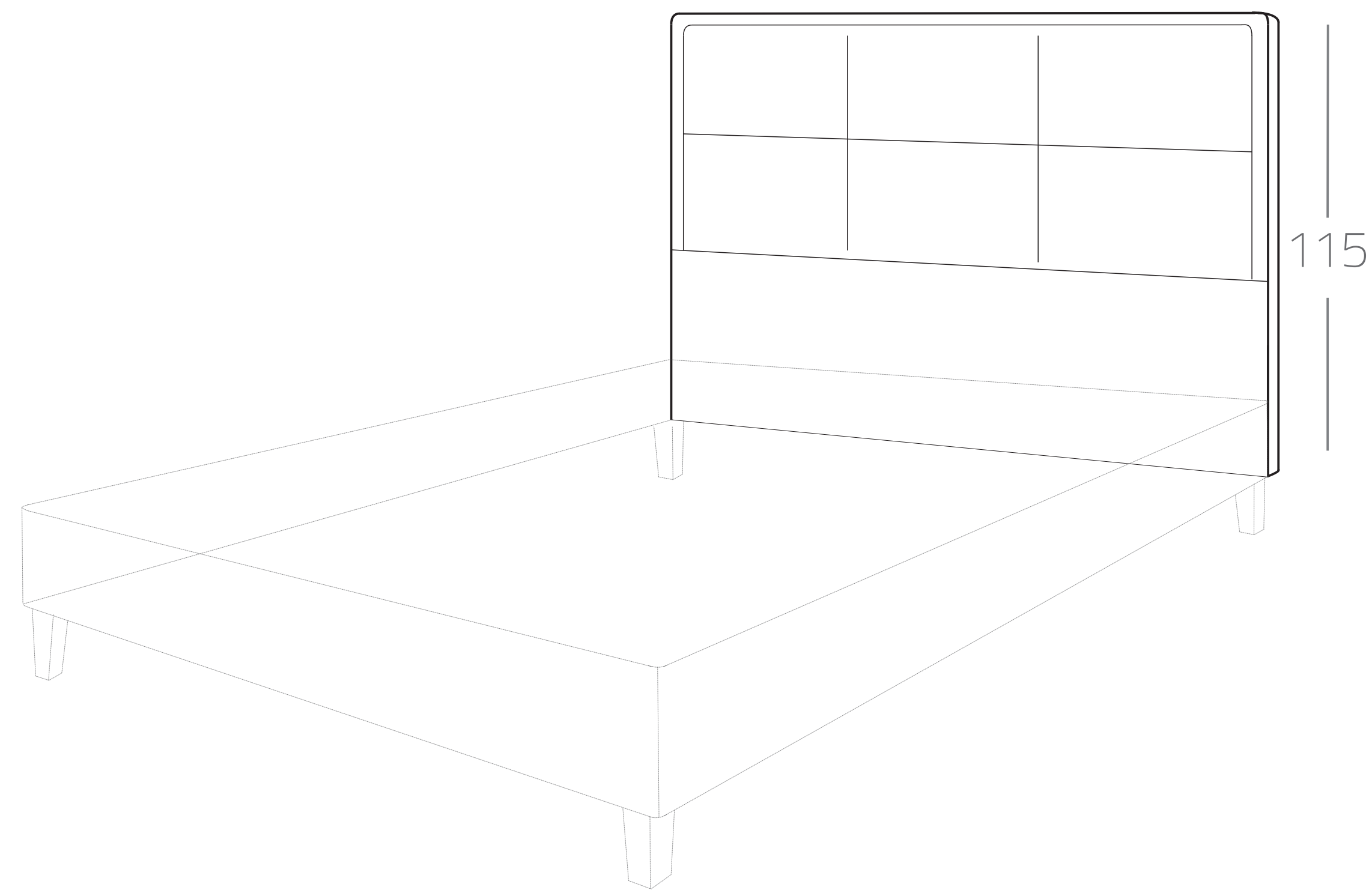

Sechs Rechtecke mit Rand  
Art. Nr.: 22x.22

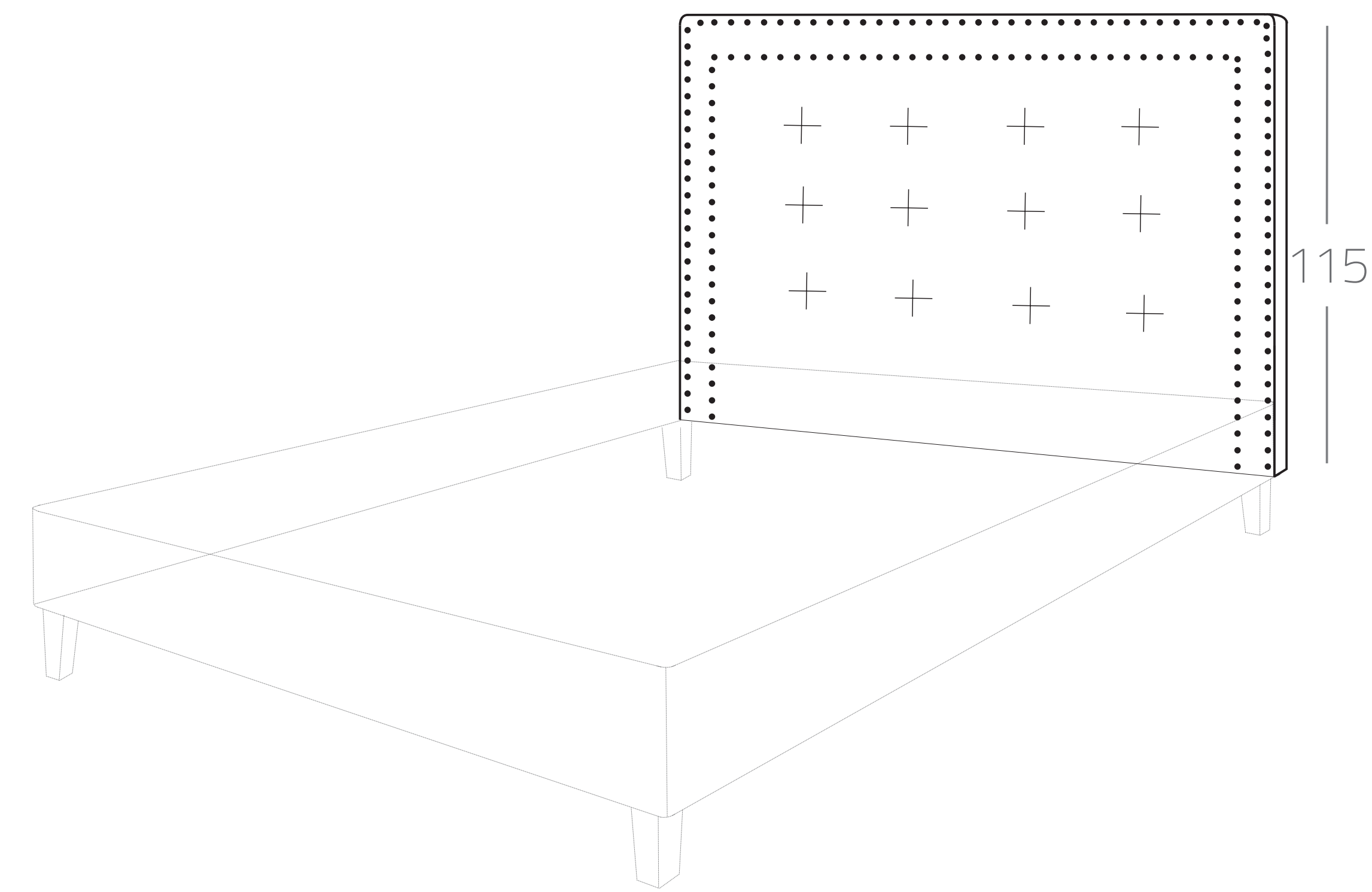

Punktabnäher & doppelte Nagelung  
Art. Nr.: 22x.21

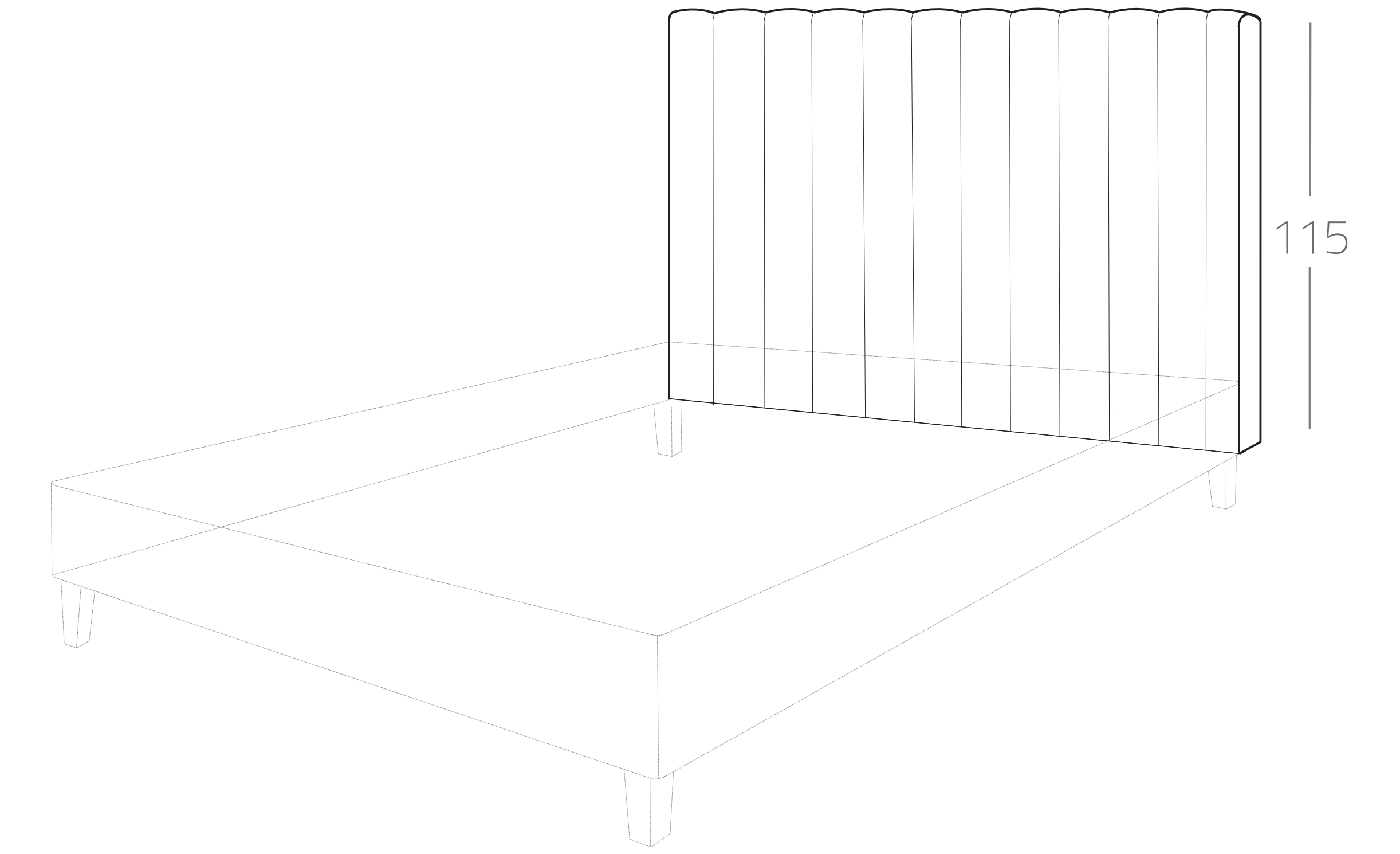

vertikale Abnäher  
Art. Nr.: 22x.26

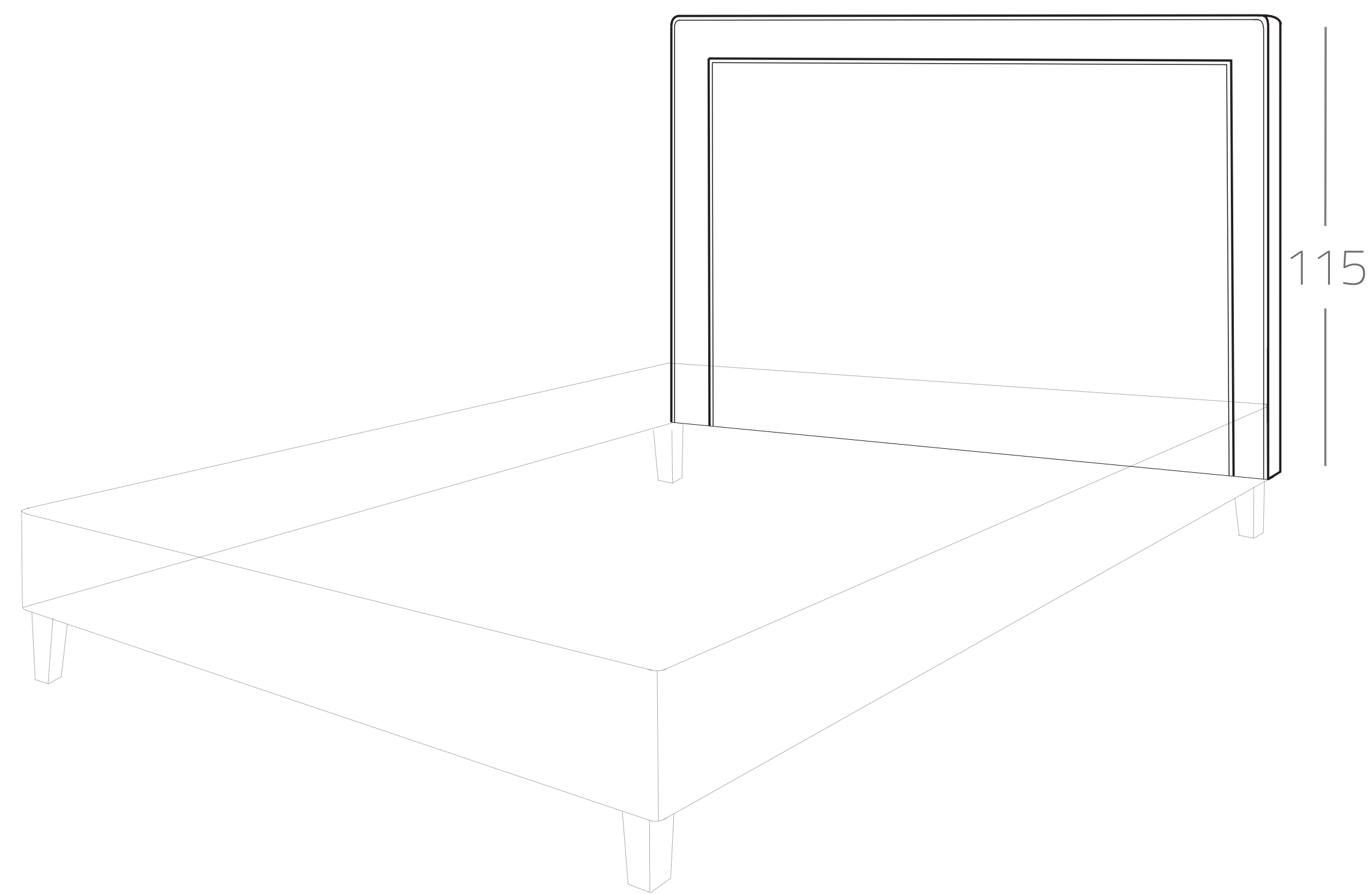

Rahmen mit Keder abgesetzt  
Art. Nr.: 22x.27

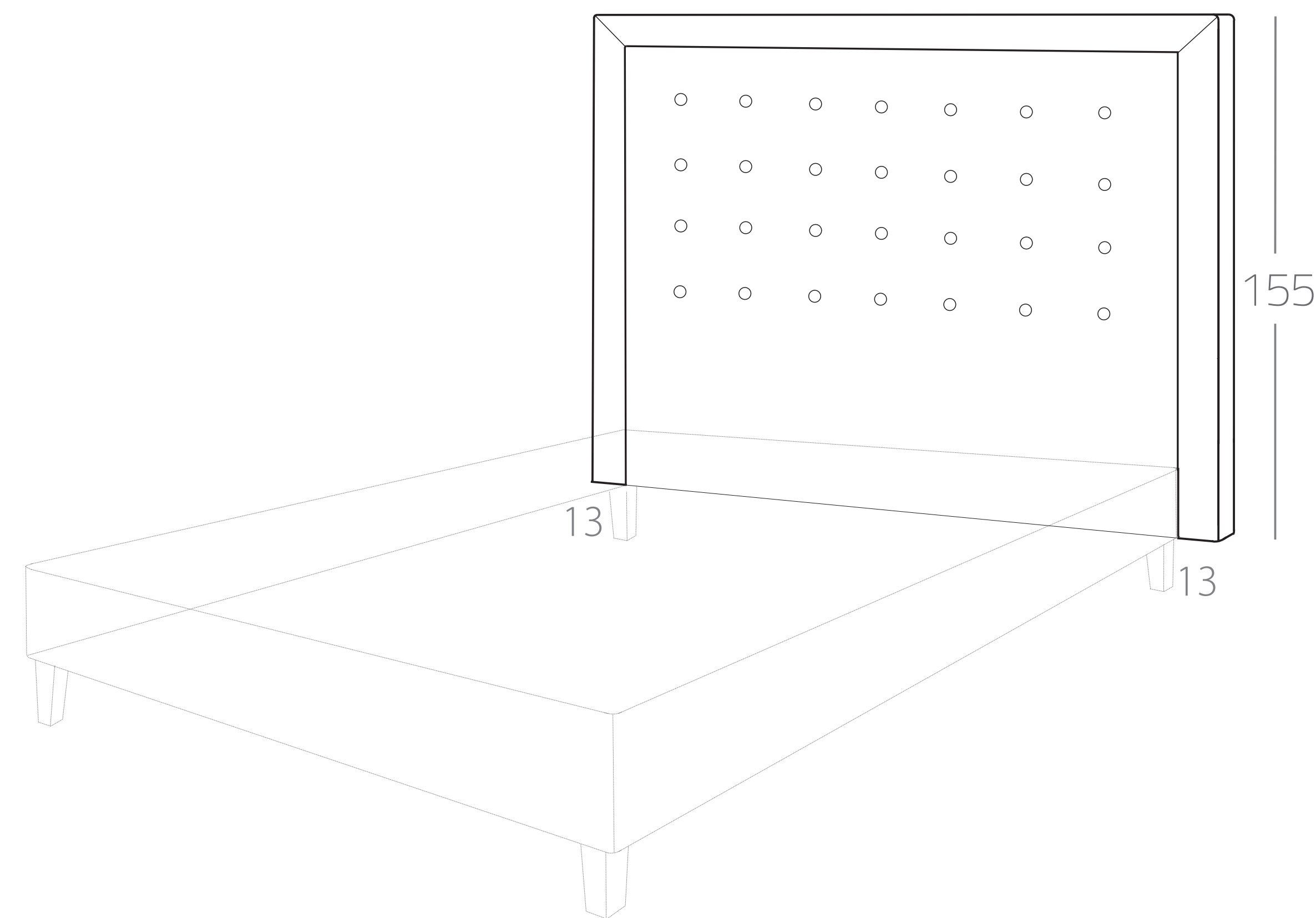

Punktabnäher & umlaufender Rand  
Art. Nr.: 22x.23

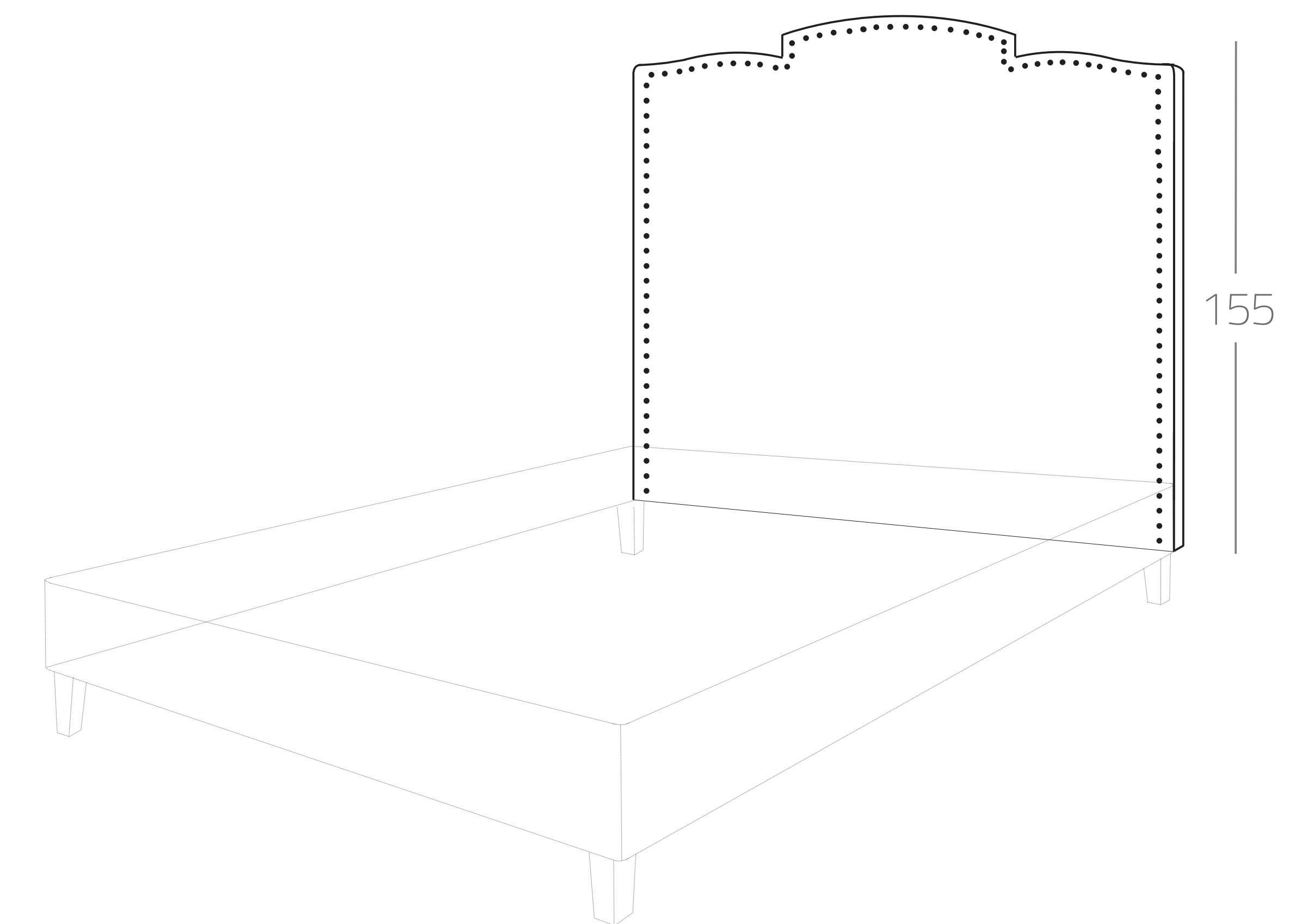

Barockstil & umlaufende Nagelung  
Art. Nr.: 22x.24

# KOPFTEILE

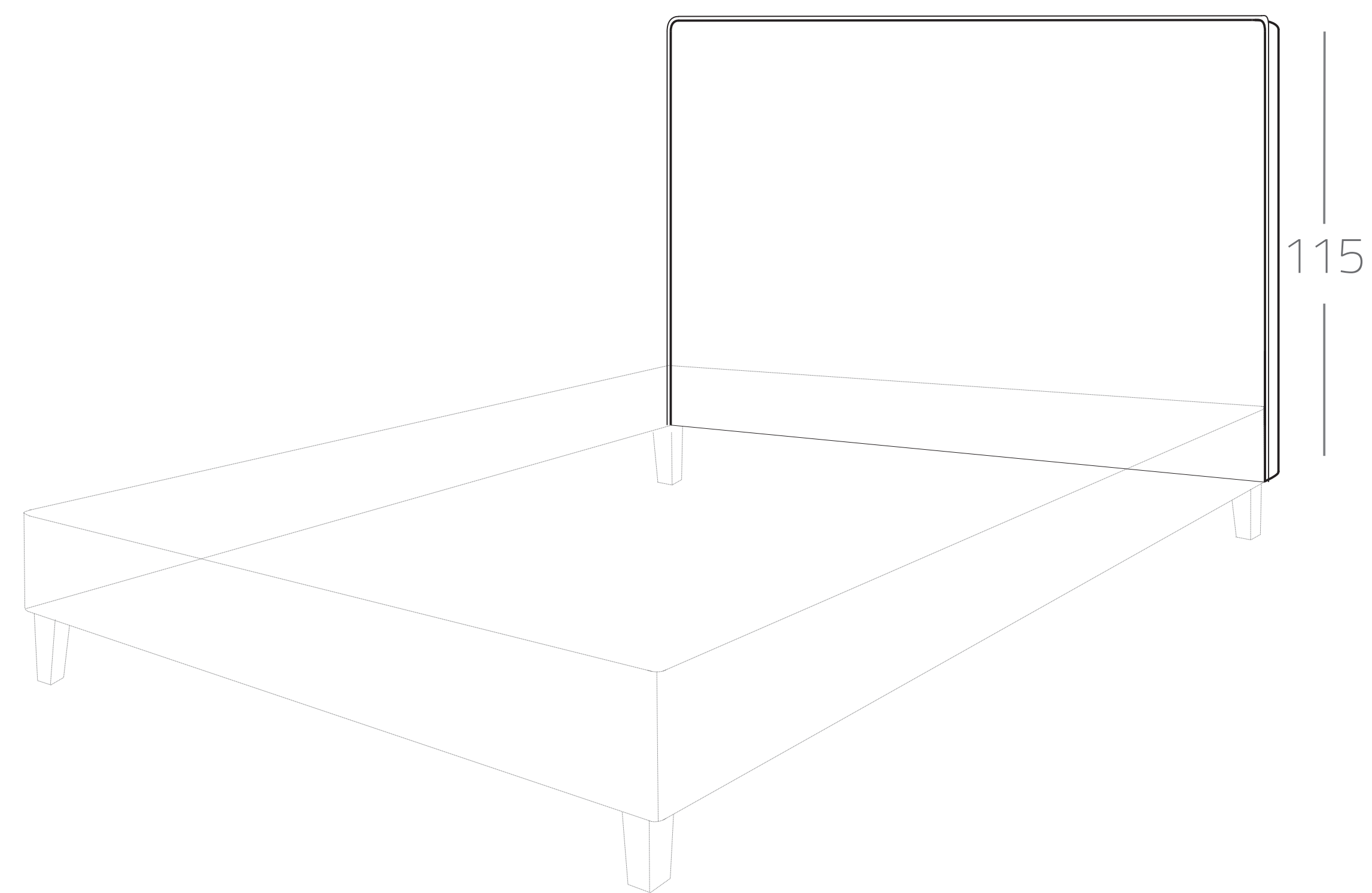

umlaufende Kedernaht  
Art. Nr.: 22x.13

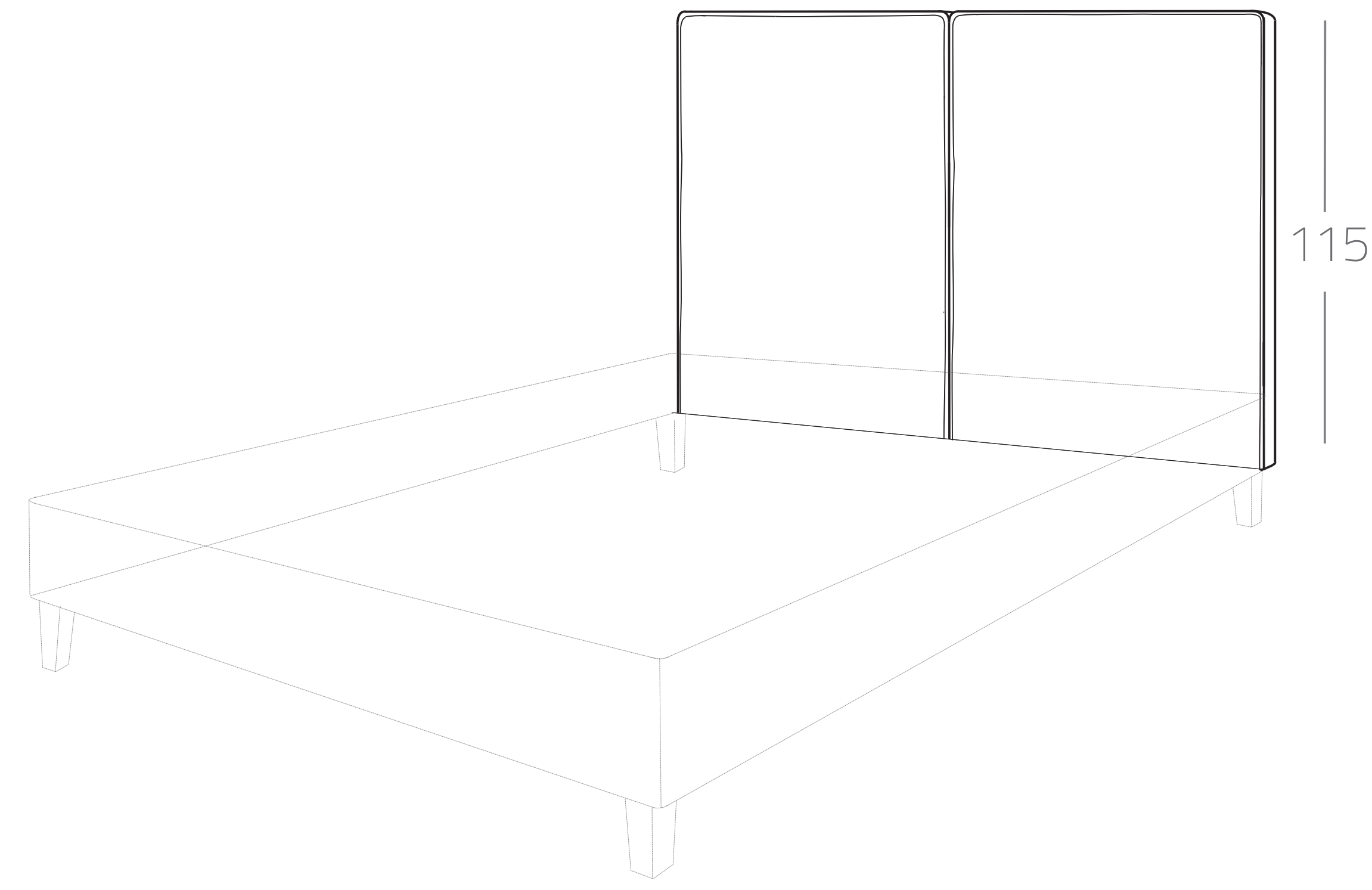

zweigeteilt mit Doppelnaht  
Art. Nr.: 22x.18

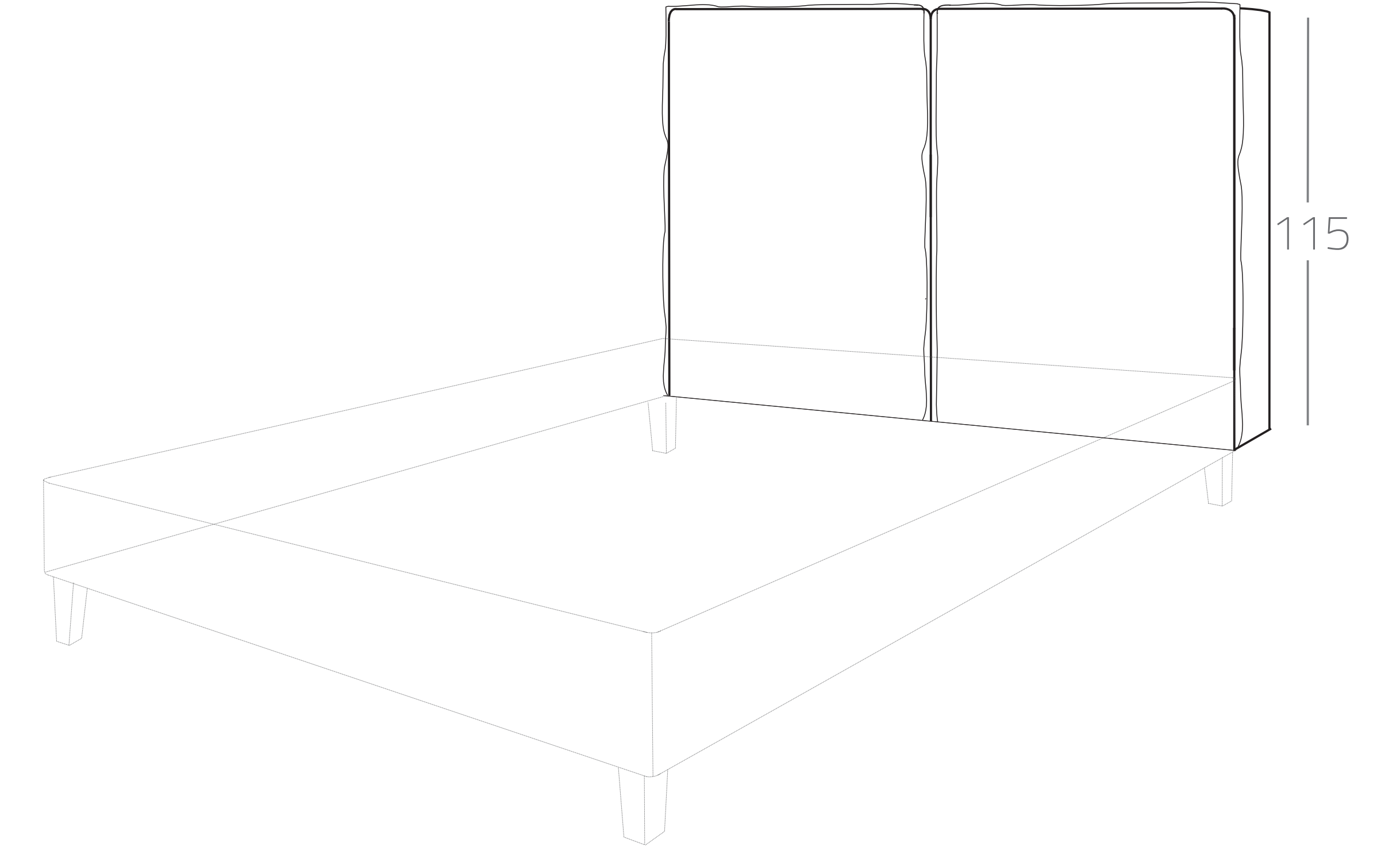

zweigeteilt mit Hohlraum  
Art. Nr.: 22x.19

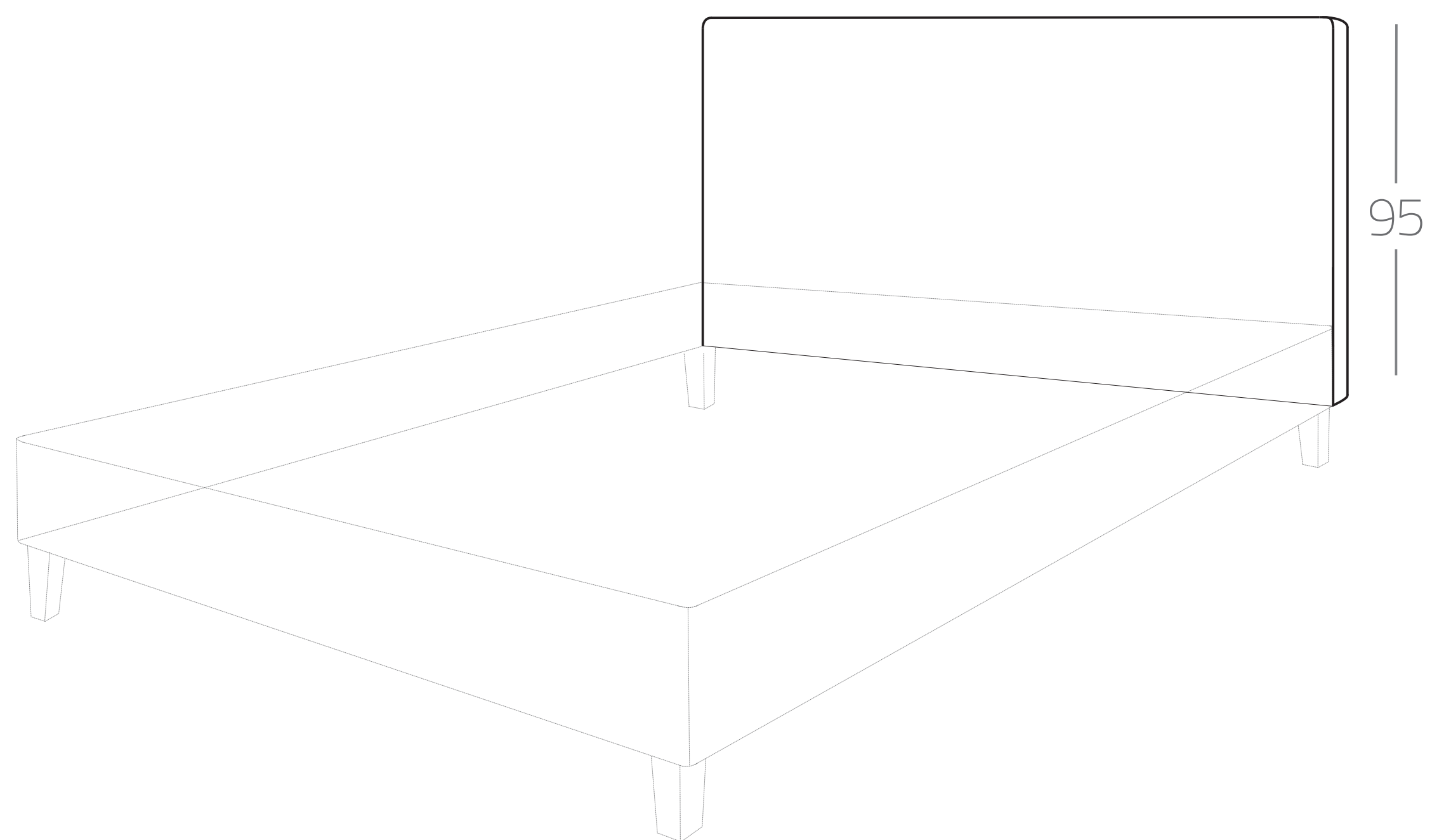

ohne Abnäher - Höhe 95cm  
Art. Nr.: 22x.25

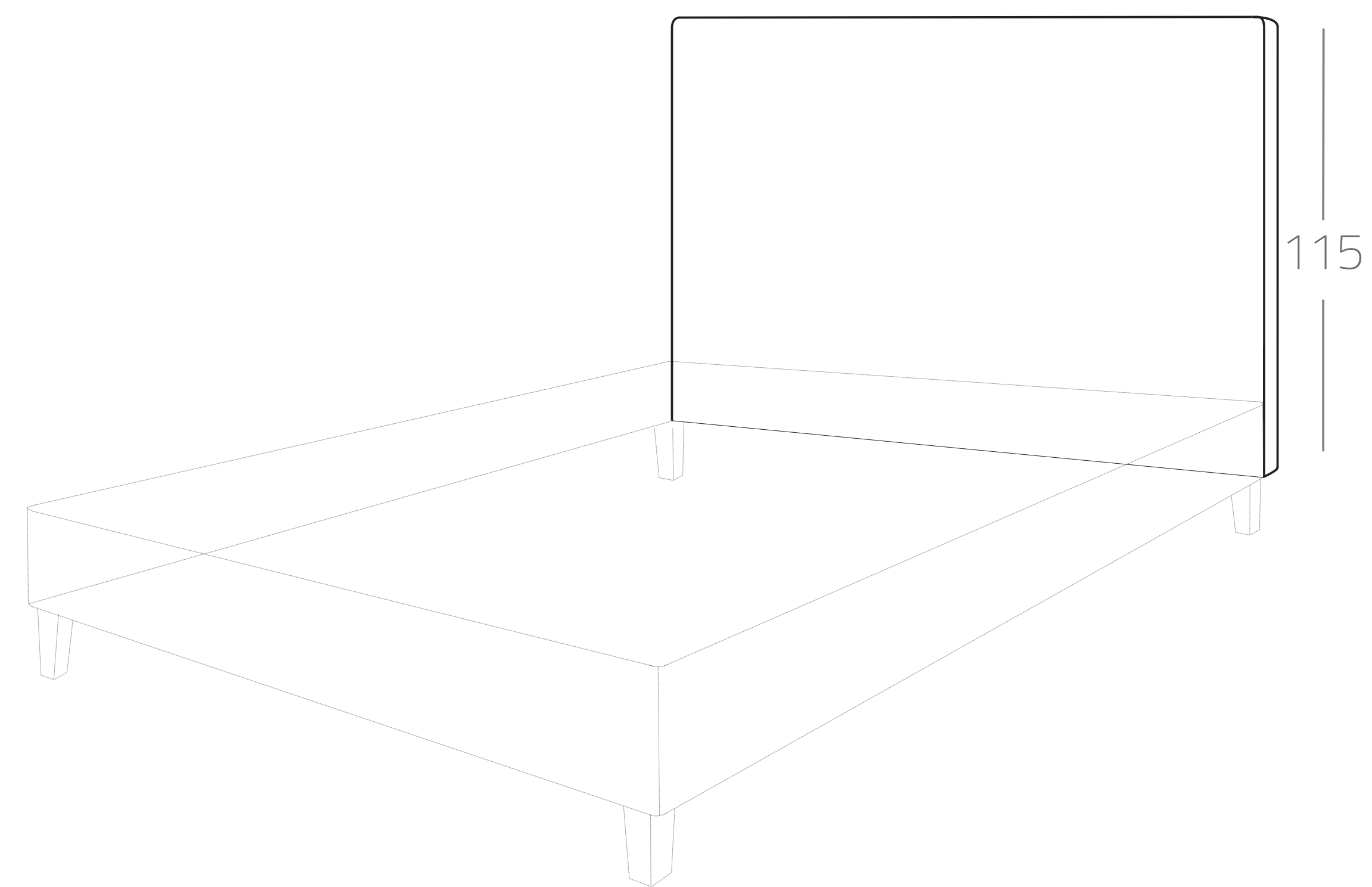

ohne Abnäher - Höhe 115cm  
Art. Nr.: 22x.17

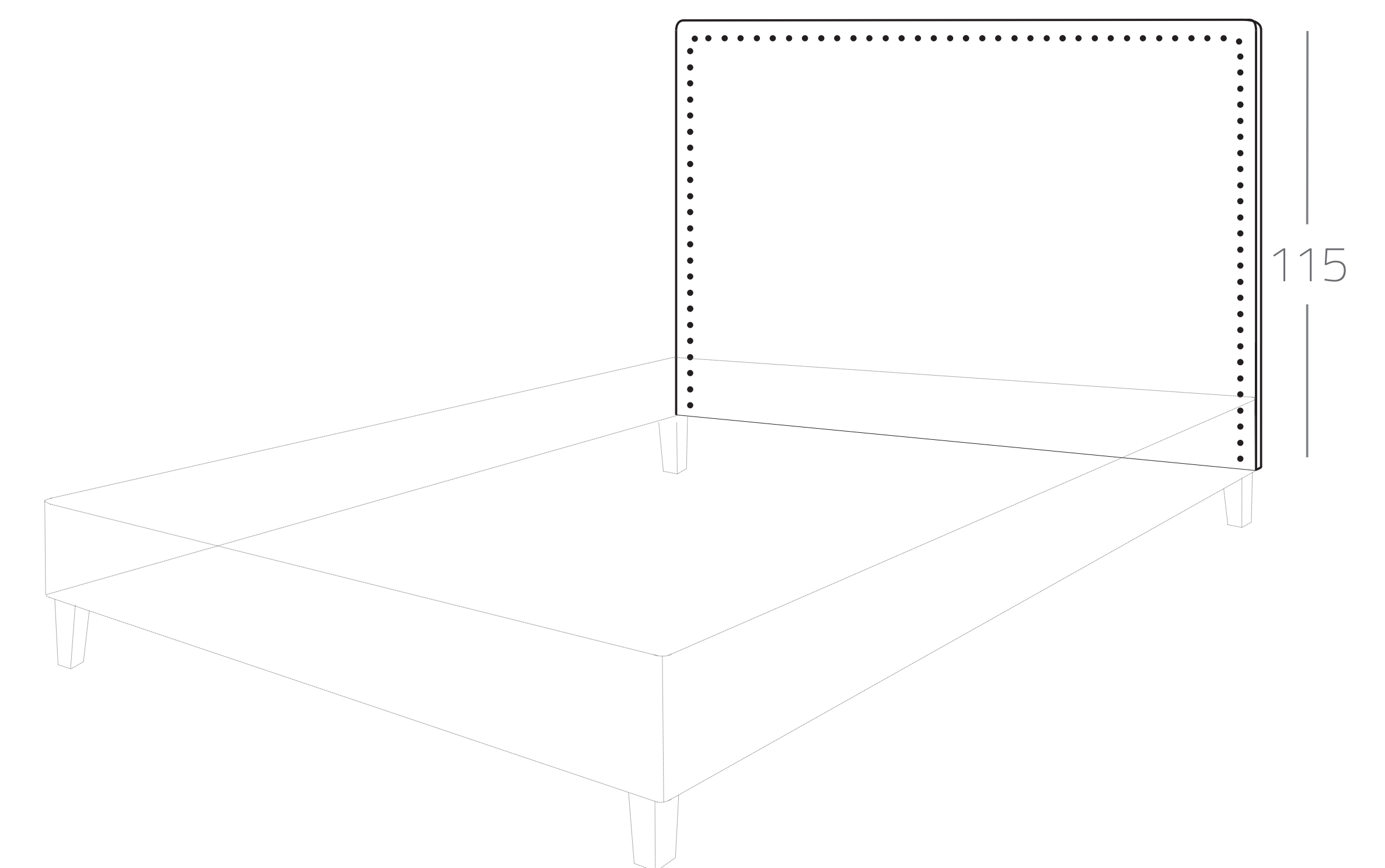

Umlaufende Nagelung  
Art. Nr.: 22x.20